

HIRT MOVING ARCHITECTURE

HIRT kinetics® HF U (elektrisch)

Vertikalschnitt

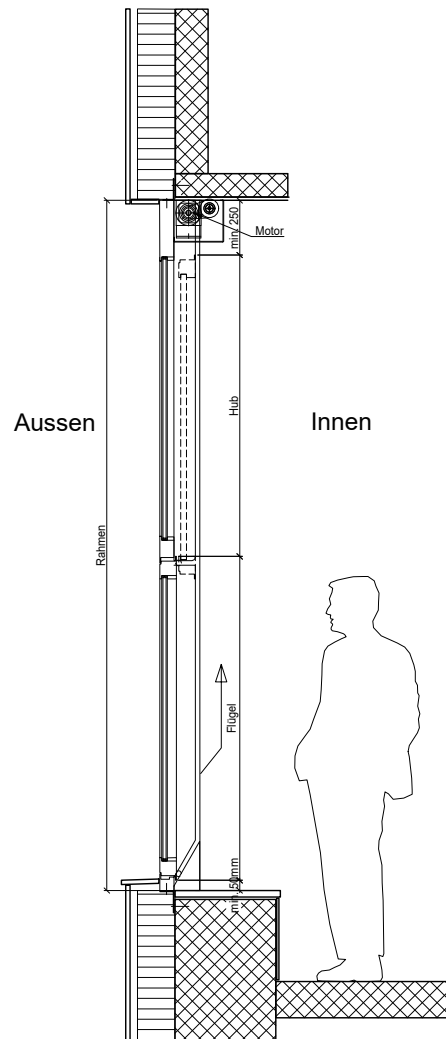

Grenzmasse motorisiert

- Breite max. 4 m
- Gewicht Flügel max. 300 kg
- Fläche max. 6 m²

Ansicht von Aussen

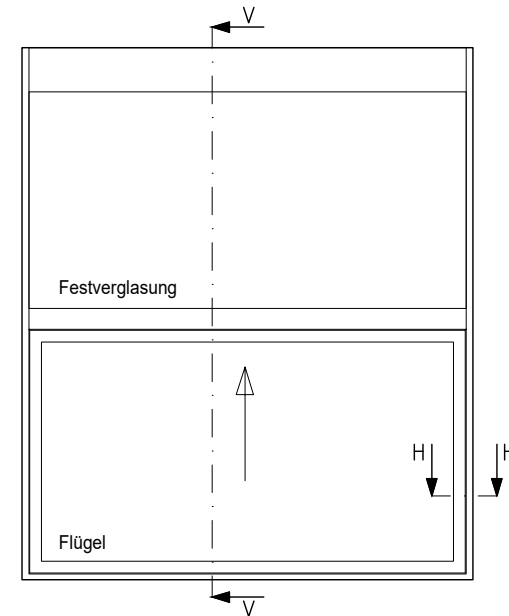

Horizontalschnitt

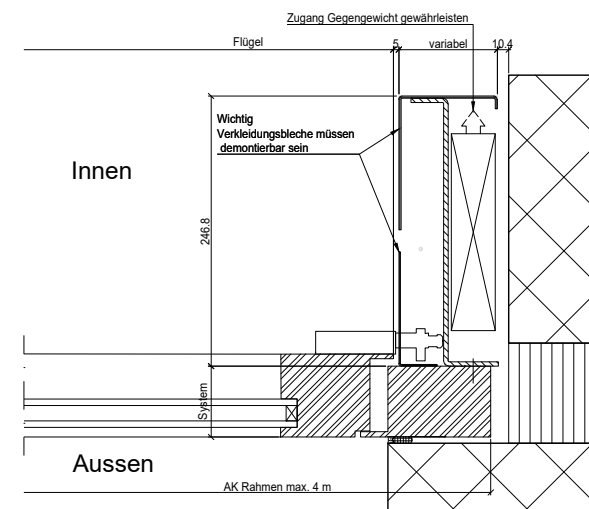

HIRT MOVING ARCHITECTURE

HIRT kinetics® HF U

Vertikalschnitt

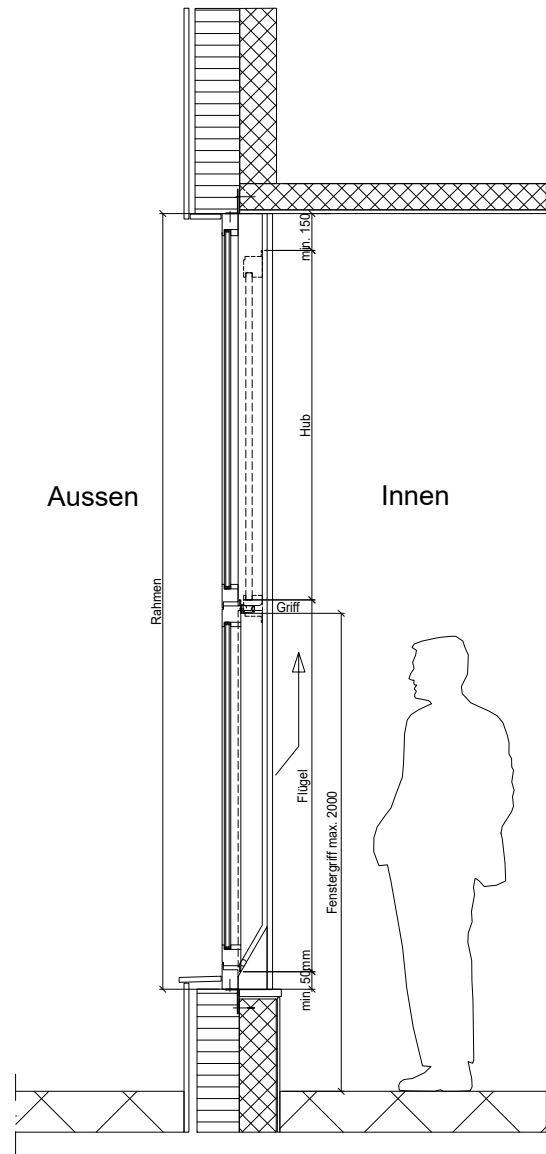

Grenzmasse

- Breite max. 4 m
- Gewicht Flügel max. 300 kg
- Fläche max. 6 m²

Ansicht von Aussen

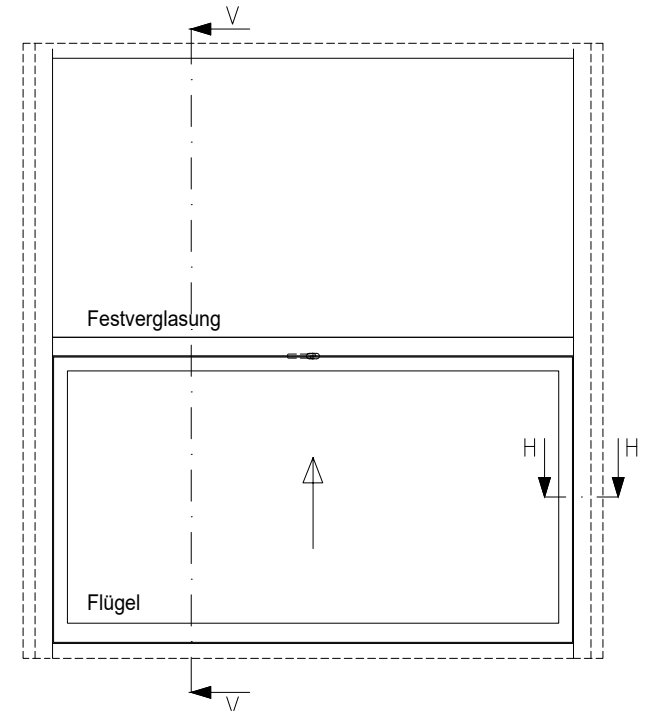

Horizontalschnitt

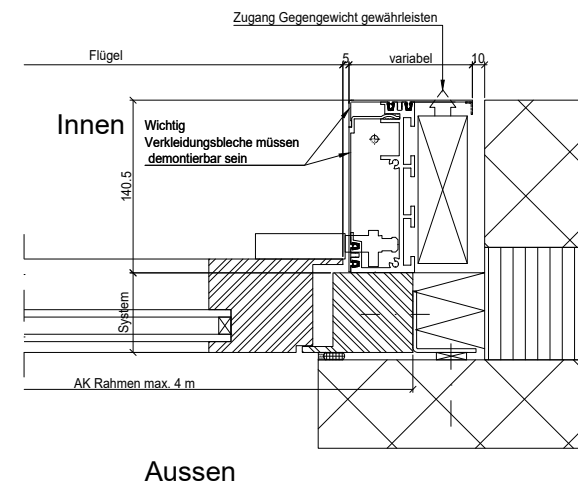

HIRT MOVING ARCHITECTURE

HIRT kinetics® HF D

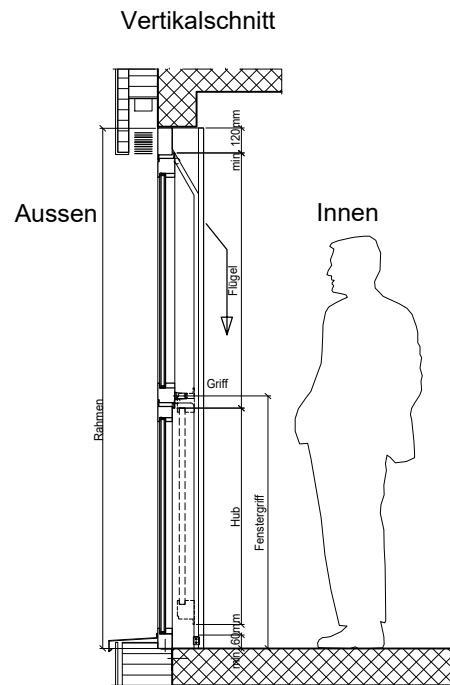

Grenzmasse

- Breite max. 4 m
- Gewicht Flügel max. 300 kg
- Fläche max. 6 m²

Ansicht von Aussen

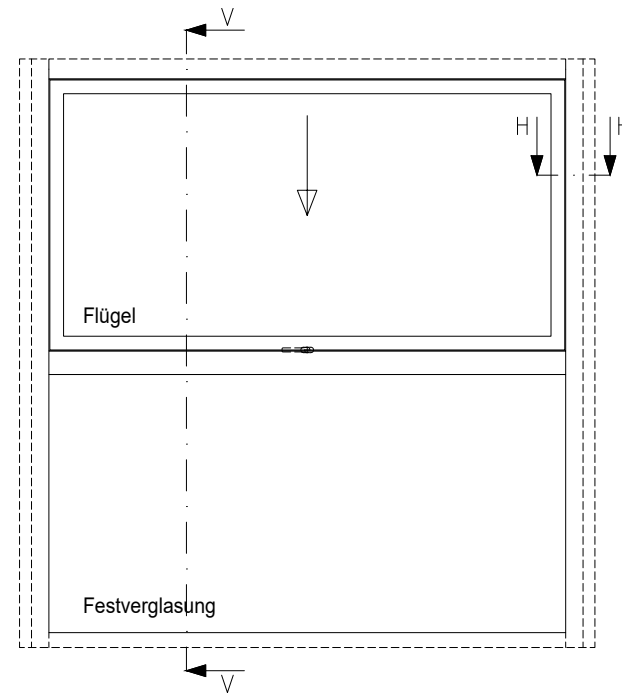

Horizontalschnitt

